

PERFORMANCE
MADE
SMARTER

产品手册

5337

二线制 HART 变送器



Segurança
INMETRO



温度 | 安全栅 | 通讯接口 | 多功能 | 隔离器 | 数显表

No. 5337V110-CN
自此序列号始: 230963319

PR
electronics

6 大特色产品

满足您的一切需求

单品出色·组合无敌

凭借创新型专利技术·信号调节更加简单·智能·产品组合由六大产品类组成·具备多种模拟量和数字量模块·涵盖上千种工业自动化应用·所有产品都符合甚至高于行业的最高标准·这可确保产品即便在最恶劣的环境条件下仍能可靠运行·5 年产品保修期·让您使用更安心·



Temperature

温度变送器和温度传感器系列产品·提供从温度测量点到系统控制一站式信号解决方案·从而在最大程度上保证信号的完整性·仅需一套点对点解决方案·您就可以在任何环境中将工业过程中的温度信号转换为模拟量信号·总线信号或数字通讯信号·该方案具备响应时间短·自动校准·传感器故障检测·低漂移和卓越 EMC 性能等诸多优点·



I.S. Interface

我们采用最严格的安全标准来检验产品·以期提供最安全的信号·秉承创新精神·我们已经在 SIL 2 全面评估本质安全型接口方面取得了开创性成就·其既高效又经济·效果卓著·成效斐然·模拟量和数字量本质安全栅种类齐全·同时提供多种输入输出·这使得 PR 标准成为一项易于实施的现场检验标准·在大型项目安装过程中·新背板方案大大简化安装和布线·且能与标准 DCS 系统无缝集成·



Communication

我们提供经济实惠·使用方便·面向未来的通讯接口·以便您能够访问所安装的 PR 产品·所有接口均可拆卸·并带有屏幕和按钮·可以显示过程值/诊断值和对参数进行配置·产品特定功能包括通过 Modbus 和蓝牙进行通讯·以及使用我们的便携式设备主管 (PPS) 应用程序进行远程访问·可用于 iOS 和 Android·



Multifunction

单品为多功能系列产品·可涵盖大量现场应用·可轻而易举按照您的现场标准进行配置·此种单品可适用多种应用方式·既节省安装和培训时间·又大大简化库存备件管理·该设备专为长期信号精度高·功耗低·抗电噪声优异·编程简单而设计·



Isolation

基于微处理器技术研发的 6 mm 隔离器·小巧精致·响应迅速·品质一流·以极低的总拥有成本为专用应用提供卓越性能和抗电磁干扰·可水平或垂直安装·装置间无需间隙·



Display

数显表系列以其灵活性和稳定性著称·该设备系列几乎满足过程信号读数显示的所有需求·并具有通用的输入和供电能力·无论哪种行业·无论环境条件何其苛刻·该设备均能实时测量过程值并提供用户友好型界面和值得信赖的继电器信号·

二线制 HART 变送器 5337

目录

应用.....	4
技术特点.....	4
安装调试.....	4
应用.....	4
订购.....	5
电气规格.....	5
附件.....	5
更改 HART 协议版本.....	8
借助 PReset 软件、5909 Loop Link 或 HART 通讯接口更改 HART 协议版本.....	8
接线方式.....	11
方框图.....	12
设置参数.....	12
变送器多点模式连接.....	14
机械规格.....	14
传感器电缆的连接.....	14
ATEX 安装图 - 5337A.....	15
ATEX 安装图 - 5337D.....	17
IECEX Installation Drawing - 5337A.....	19
IECEX Installation Drawing - 5337D.....	21
CSA Installation Drawing - 5337A.....	23
CSA Installation Drawing - 5337D.....	24
FM Installation Drawing - 5337D.....	25
INMETRO Installation Drawing - 5337A.....	27
INMETRO Installation Drawing - 5337D.....	29
文档更新记录.....	31

二线制 HART 变送器 5337

- RTD、TC、Ohm 和双极性 mV 信号输入
- 两路模拟量输入和五个设备变量 (带状态变量)
- HART 5 或 HART 7 协议版本切换
- 符合 SIL 应用要求的硬件评估
- 安装于安全区域或危险气体和粉尘区域中的 DIN 导轨上

应用

- TC 或 RTD 传感器线性化温度测量，例如 Pt100 和 Ni100。
- 两个 RTD 或 TC 输入信号单值、差值或平均值 4...20 mA 模拟量 PV 值输出，以及 HART 通讯。
- 转换线性电阻阻值变化为标准模拟量电流信号，例如：阀信号，或欧姆输出液位计。
- 转换双极性 mV 信号为标准 4...20 mA 电流信号。
- HART 7 多点通讯模式下可连接多达63个变送器进行数字通讯。

技术特点

- HART 7 协议提供：
 - 长位号名，可多达32个字符。
 - 增强的突发送模式 (Burst Mode) 以及带时间标签的事件通知。
 - 设备变量和状态可以映射到任何动态变量 PV、SV、TV 或 QV。
 - 带记录和汇总数据的过程信号趋势测量。
 - 带时间标签的自动事件通知。
 - 具备更高通讯效率的指令集。
- 5337D 按照严格的安全要求进行设计，因此适用于 SIL 安装应用。
- 持续监测重要数据，保障使用安全。
- 符合 NAMUR NE21 要求，5337 HART 变送器能在严苛 EMC 环境下提供顶级的测量性能。此外，5337D 也同时符合 NAMUR NE43 和 NE89 标准要求。

安装调试

- 标准 DIN B型传感器头部安装。
- 通过标准 HART 或 PR 5909 通讯器设定参数。

应用

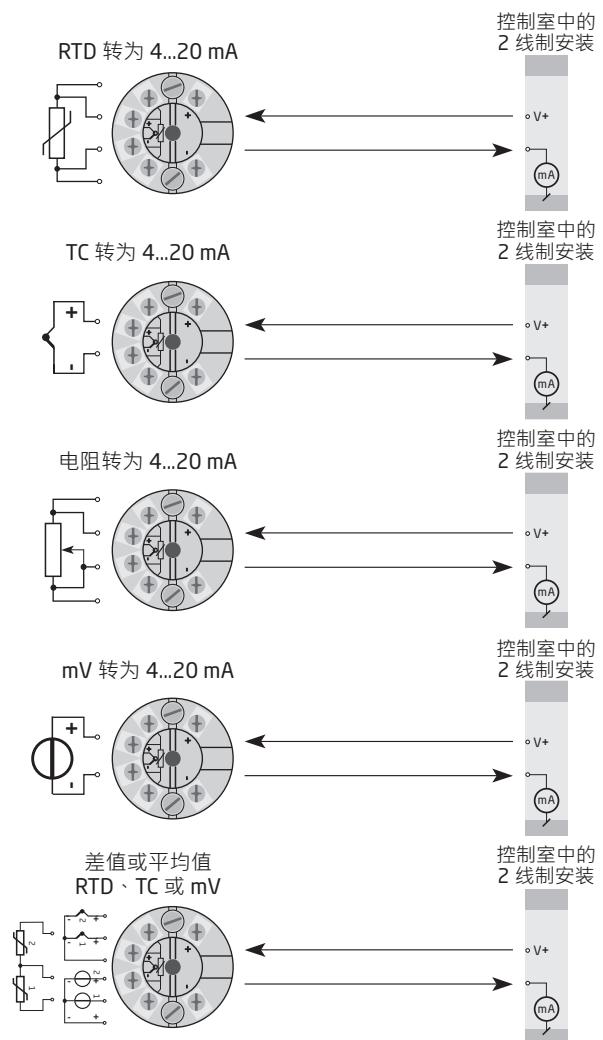

订购

型号	版本
5337	Zone 2 / Div. 2 : A
	Zone 0 · 1 · 2 · 21 · 22 · M1 / DIV.1 · DIV.2 : D

附件

5909 = USB 接口 Loop Link 和 PReset 软件
8421 = DIN 导轨卡扣

电气规格

环境条件:

规格温度范围	--40°C 至 +85°C
标定温度	20...28°C
湿度	< 95% RH (无冷凝)
防护等级 (外壳/端子)	IP68 / IP00

机械规格:

结构尺寸	Ø 44 x 20.2 mm
重量 (大约)	50 g
最大导线规格	1 x 1.5 mm ² 绞线
螺丝端子力矩	0,4 Nm
抗振规格	IEC 60068-2-6
2...25 Hz	±1.6 mm
25...100 Hz	±4 g

常用规格:

电源电压 · DC	
5337A	8.0...35 VDC
5337D	8.0...30 VDC
内部功率耗散	
5337A	25 mW...0.8 W
5337D	25 mW...0.7 W
电压降	8.0 VDC
隔离电压 · 测试/工作	1.5 kVAC / 50 VAC
设置参数	Loop Link 和 HART
信噪比	> 60 dB
响应时间 (可设定)	1...60 s
信号动态范围 · 输入	22 位
信号动态范围 · 输出	16 位

精度·取一般值和基本值中较大的那一个：

一般值		
输入类型	绝对精度	温度系数
所有	$\leq \pm 0.05\%$ 所设量程	$\leq \pm 0.005\%$ 所设量程/ $^{\circ}\text{C}$

基本值		
输入类型	基本精度	温度系数
Pt50 - Pt1000	$\leq \pm 0.1^{\circ}\text{C}$	$\leq \pm 0.005^{\circ}\text{C}/^{\circ}\text{C}$
Ni50 - Ni1000	$\leq \pm 0.2^{\circ}\text{C}$	$\leq \pm 0.005^{\circ}\text{C}/^{\circ}\text{C}$
线性电阻	$\leq \pm 0.1 \Omega$	$\leq \pm 5 \text{ m}\Omega / ^{\circ}\text{C}$
电压	$\leq \pm 10 \mu\text{V}$	$\leq \pm 0.5 \mu\text{V} / ^{\circ}\text{C}$
TC 型号： E、J、K、L、N、T、U	$\leq \pm 0.5^{\circ}\text{C}$	$\leq \pm 0.025^{\circ}\text{C} / ^{\circ}\text{C}$
TC 型号： B ¹ 、Lr、R、S、W3、W5	$\leq \pm 1^{\circ}\text{C}$	$\leq \pm 0.1^{\circ}\text{C} / ^{\circ}\text{C}$
TC 型号：B ²	$\leq \pm 3^{\circ}\text{C}$	$\leq \pm 0.3^{\circ}\text{C} / ^{\circ}\text{C}$
TC 型号：B ³	$\leq \pm 8^{\circ}\text{C}$	$\leq \pm 0.8^{\circ}\text{C} / ^{\circ}\text{C}$
TC 型号：B ⁴	未指定	未指定

TC B¹ 精度规格适用范围. > 400 $^{\circ}\text{C}$
 TC B² 精度规格适用范围. > 160 $^{\circ}\text{C}$ < 400 $^{\circ}\text{C}$
 TC B³ 精度规格适用范围. > 85 $^{\circ}\text{C}$ < 160 $^{\circ}\text{C}$
 TC B⁴ 精度规格适用范围. < 85 $^{\circ}\text{C}$

TC 冷端补偿. < $\pm 1.0^{\circ}\text{C}$
 输入信号最大偏移量. 所设量程高值的 50%

EMC – 抗扰性影响.	< $\pm 0.1\%$ 所设量程
扩展的 EMC 电磁兼容： NAMUR NE 21, A criterion, burst.	< $\pm 1\%$ 所设量程

输入规格：

RTD 输入类型：

RTD 类型	最小值	最大值	最小量程	标准
Pt100	-200 $^{\circ}\text{C}$	+850 $^{\circ}\text{C}$	10 $^{\circ}\text{C}$	IEC 60751
Ni100	-60 $^{\circ}\text{C}$	+250 $^{\circ}\text{C}$	10 $^{\circ}\text{C}$	DIN 43760
线性电阻	0 Ω	7000 Ω	25 Ω	-----

Pt50、Pt100、Pt200、Pt500、Pt1000、Ni50、Ni100、Ni120、Ni1000
 单根导线电缆电阻 (最大) 5 Ω
 (降低测量精度后·单根导线最大可达 50 Ω)
 传感器电流 额定 0.2 mA

TC 输入类型：

型号	最低温度	最高温度	最小量程	标准
B	0°C	+1820°C	100°C	IEC584
E	-100°C	+1000°C	50°C	IEC584
J	-100°C	+1200°C	50°C	IEC584
K	-180°C	+1372°C	50°C	IEC584
L	-200°C	+900°C	50°C	DIN 43710
Lr	-200°C	+800°C	50°C	GOST 3044-84
N	-180°C	+1300°C	50°C	IEC584
R	-50°C	+1760°C	100°C	IEC584
S	-50°C	+1760°C	100°C	IEC584
T	-200°C	+400°C	50°C	IEC584
U	-200°C	+600°C	50°C	DIN 43710
W3	0°C	+2300°C	100°C	ASTM E988-90
W5	0°C	+2300°C	100°C	ASTM E988-90

冷端补偿 (CJC)：

固定补偿 · 通过 Pt100 或 Ni100 传感器实现内部或外部补偿

mV 输入：

测量范围	-800...+800 mV
最小量程	2.5 mV
输入电阻	10 MΩ

输出规格和 HART：

信号范围	4...20 mA
最小信号范围	16 mA
更新时间	440 ms
负载电阻	≤ (V _{电源} - 8) / 0.023 [Ω]
传感器故障检测 · 可设定	3.5...23 mA
(在选择 TC 和 mV 输入时不检测传感器短路报警)	
NAMUR NE43 上限	23 mA
NAMUR NE43 下限	3.5 mA
HART 协议修订版本	HART 5 和 HART 7

所设量程 = 当前设定的量程范围

遵守主管机关要求：

EMC	2014/30/EU & UK SI 2016/1091
ATEX	2014/34/EU & UK SI 2016/1107
RoHS	2011/65/EU & UK SI 2012/3032
EAC	TR-CU 020/2011
EAC Ex	TR-CU 012/2011

认证：

DNV · 船舶和近海	TAA0000101
-------------	------------

本质安全/ 防爆认证：

5337A：	
ATEX	DEKRA 20ATEX0109 X
5337D：	
ATEX	DEKRA 20ATEX0108 X
FM	FM17US0013X
5337A & 5337D：	
IECEx	DEK 20.0063X
CSA	1125003
INMETRO	DEKRA 23.0011X
EAC Ex	EAEU KZ 7500361.01.01.08756

功能安全：

符合 SIL 应用要求的硬件评估

FMEDA 报告下载 - www.prelectronics.com

更改 HART 协议版本

可以使用 PReset 软件和 PR 5909 Loop Link 或 HART 接口更改本机的 HART 协议版本。
还可以使用其他 HART 配置工具，如手持式 HART 终端。

使用 HART 手持终端将 5337 从 HART 7 更改为 HART 5 的步骤，反之亦然：

将 5337 从 HART 7 更改为 HART 5：

驱动 5337 设备 **Online** (在线)，并进入 **Device setup** (设备设置) - **Diag/Service** (诊断/服务)。
选择 **Write protection** (写保护)，然后选择 **Write protect** (写保护)，在对话框中输入“*****” (8 个星号)，并确认。
再选择 **New password** (新密码) - 在对话框中输入“*****” (8 个星号)，点击确认，然后再在新对话框中输入“HARTREV5”，点击确认。
最后选择 **Write enable** (允许写入)，并在对话框中输入“-CHANGE-”，点击确认即可。

将 5335 (5337) 从 HART 5 更改为 HART 7：

驱动 5335 设备 **Online** (在线)，并进入 **Device setup** (设备设置) - **Diag/Service** (诊断/服务)。
选择 **Write protection** (写保护)，然后选择 **Write protect** (写保护)，在对话框中输入“*****” (8 个星号)，并确认。
再选择 **New password** (新密码) - 在对话框中输入“*****” (8 个星号)，点击确认，然后再在新的对话框中输入“HARTREV7”，点击确认。
最后选择 **Write enable** (允许写入)，并在对话框中输入“-CHANGE-”，点击确认即可。

请注意：只有在变送器标签上标有“5337”时，方可执行此项操作！

借助 PReset 软件、5909 Loop Link 或 HART 通讯接口更改 HART 协议版本

从 HART 7 切换到 HART 5：

选择 5337 产品，单击“HART”选项卡，并打开文件夹“Methods” (方法)。
单击 **Device Password / Write Protection / Protocol...** (设备密码 / 写保护 / 协议...)，在弹出的窗口中选择“Change protocol to HART 5” (更改协议到 HART 5)，然后按 OK 确认。

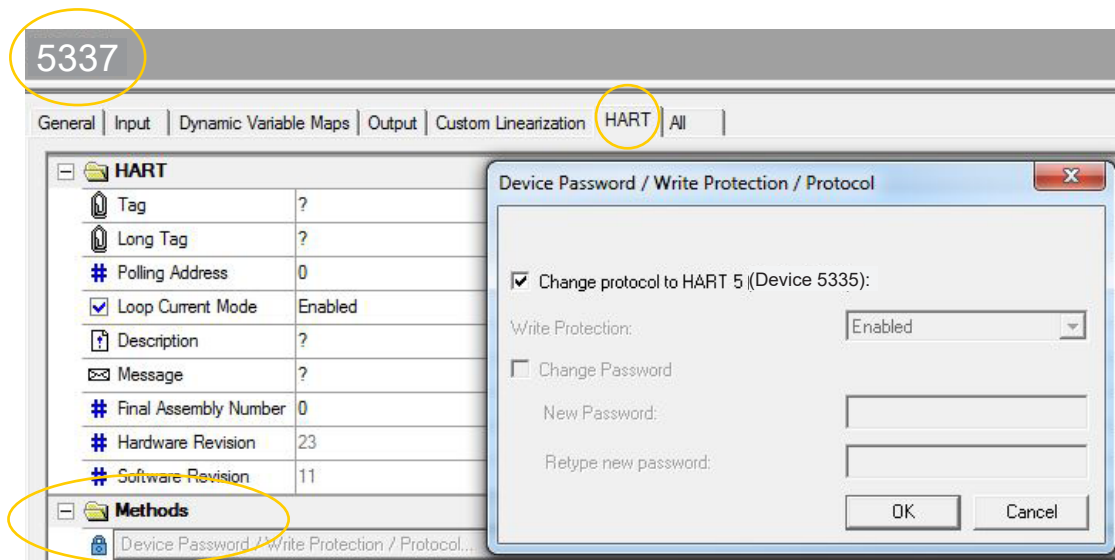

之后将出现以下消息：

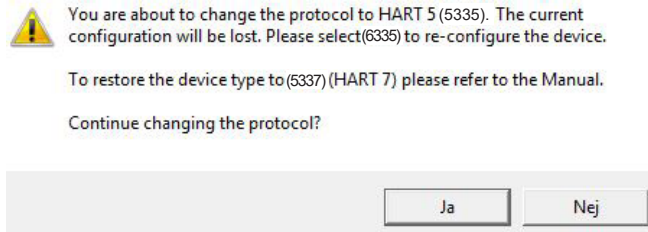

如果您按下“Ja”（确定）：

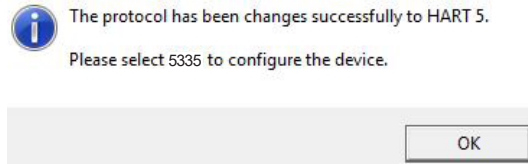

从 HART 5 切换到 HART 7：

请注意：只有在变送器标签上标有“5337”时，方可执行此项操作！

从 PReset 选择 5335 产品，单击“OPTIONS”（选项）选项卡，然后单击“Protect”（保护）。必须将写保护设为“ON”（开启）。选中Change Password（更改密码）。在 New Password（新密码）对话框中输入“HARTREV7”，然后在 Re-enter New（再次输入新密码）对话框中再次输入“HARTREV7”。点击“OK”确认。

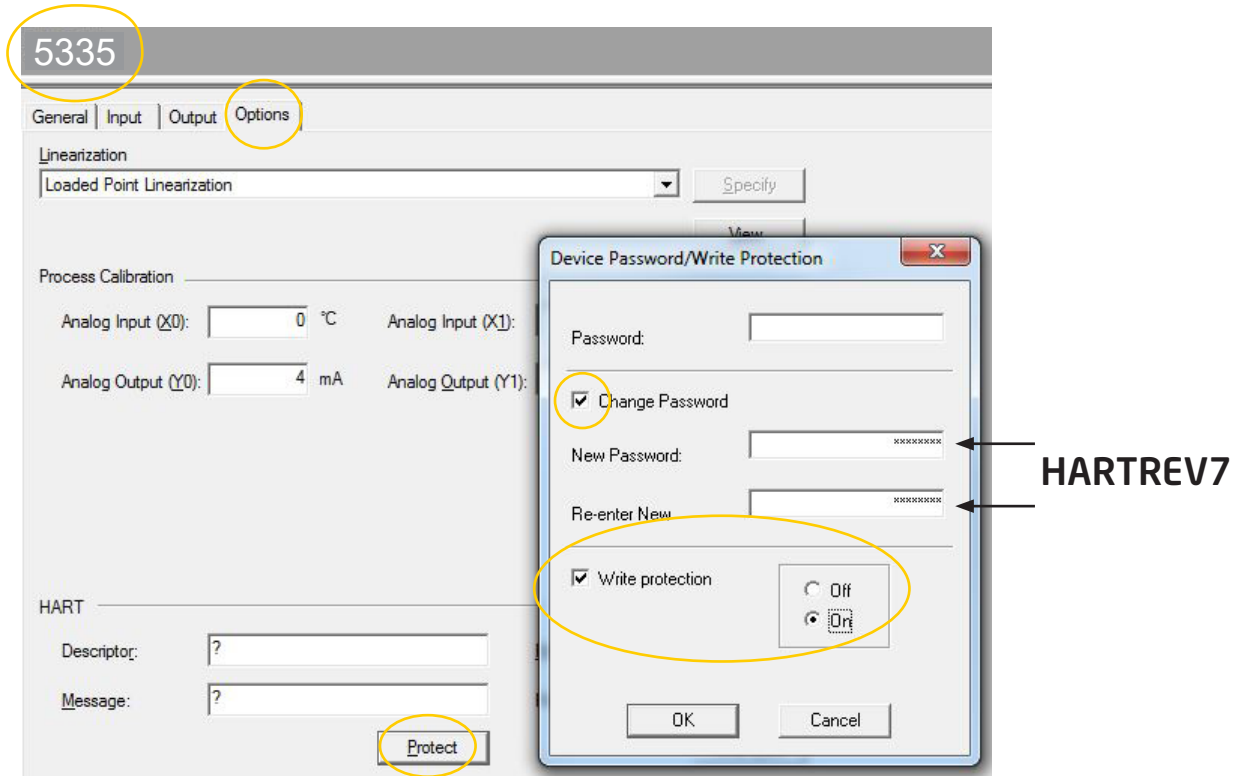

选择 **Write protection OFF** (写保护关闭) · 同时在顶部 **Password** (密码) 对话框中输入 **"-CHANGE-"** - 并点击 **"OK"** 确认。
此操作可将密码重置为默认激活密码 **"*****"** (8 个星号) · 并在禁用写保护的情况下在 HART 7 更新模式下重启设备 · 现在选择 PReset 中的 5337 · 并重新配置设备。

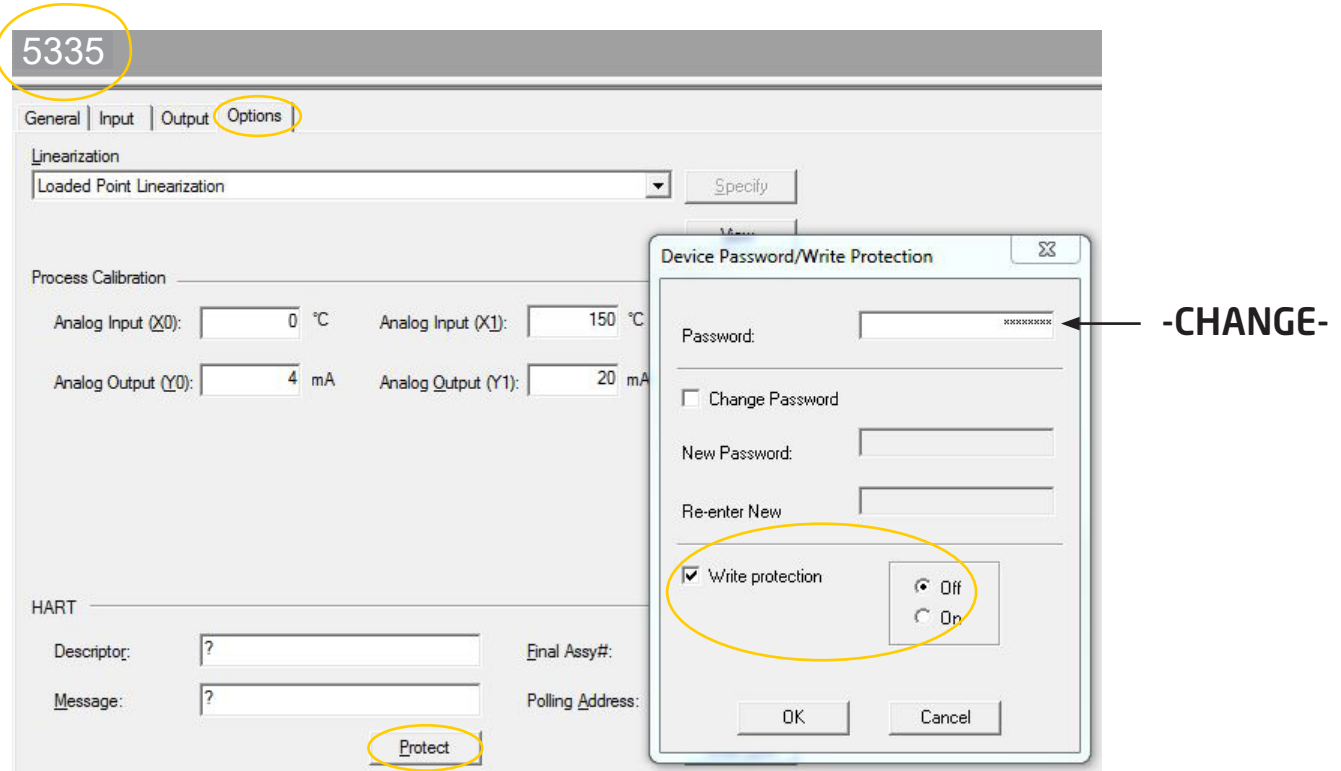

接线方式

输入：

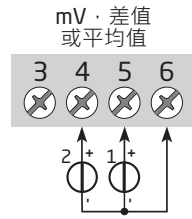
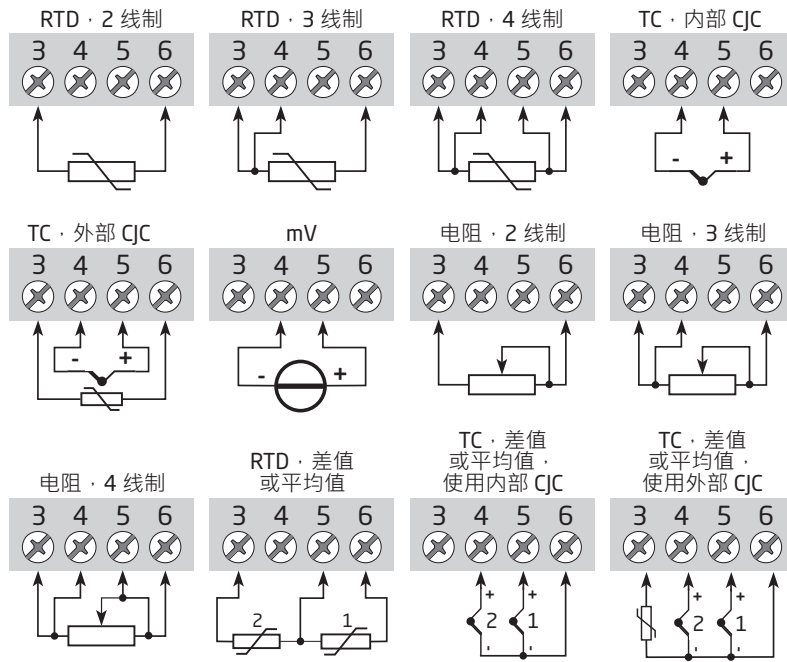

输出：

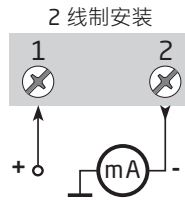

方框图

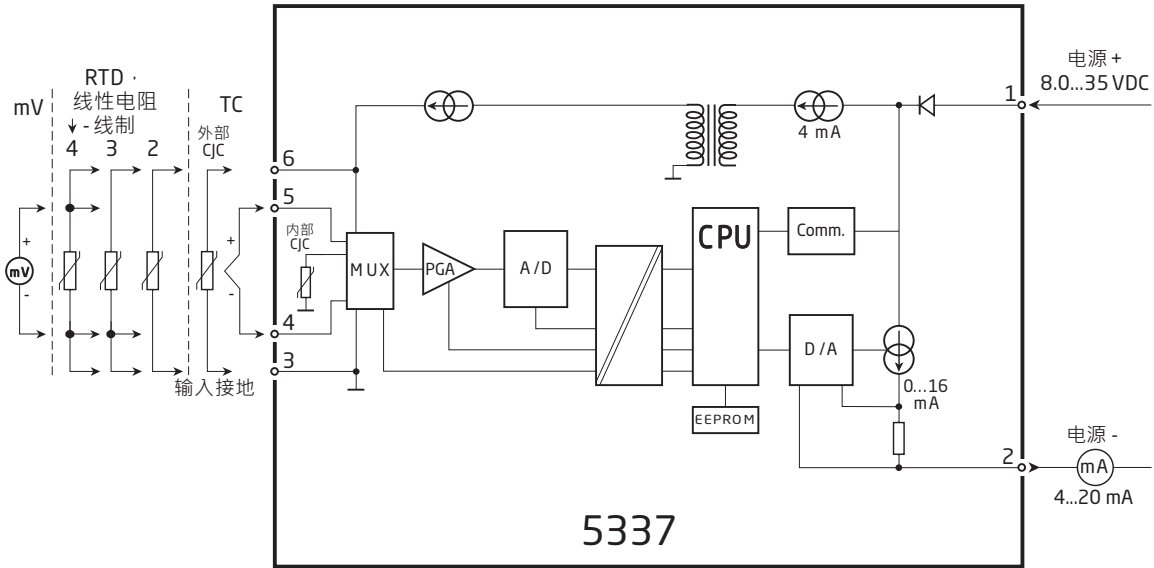

设置参数

5337 可以通过以下 3 种方式进行配置：

1. 通过 PR electronics A/S 的通信接口 Loop Link 和电脑 PReset 配置软件。
2. 通过 HART 调制解调器和电脑 PReset 配置软件。
3. 通过具备 PR electronics A/S' DDL 驱动的 HART 通信器。

1: Loop Link

有关配置相关内容，请参阅下图和 PReset 软件中的帮助功能。

Loop Link 不允许与危险 (Ex) 区域中安装的设备进行通信。

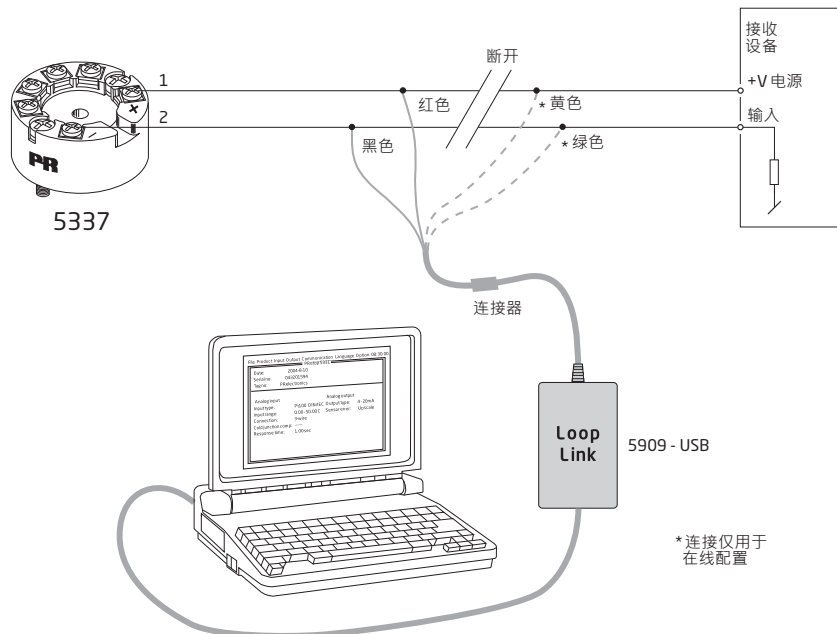

2: HART 调制解调器

有关配置相关内容，请参阅下图和 PReset 软件中的帮助功能。

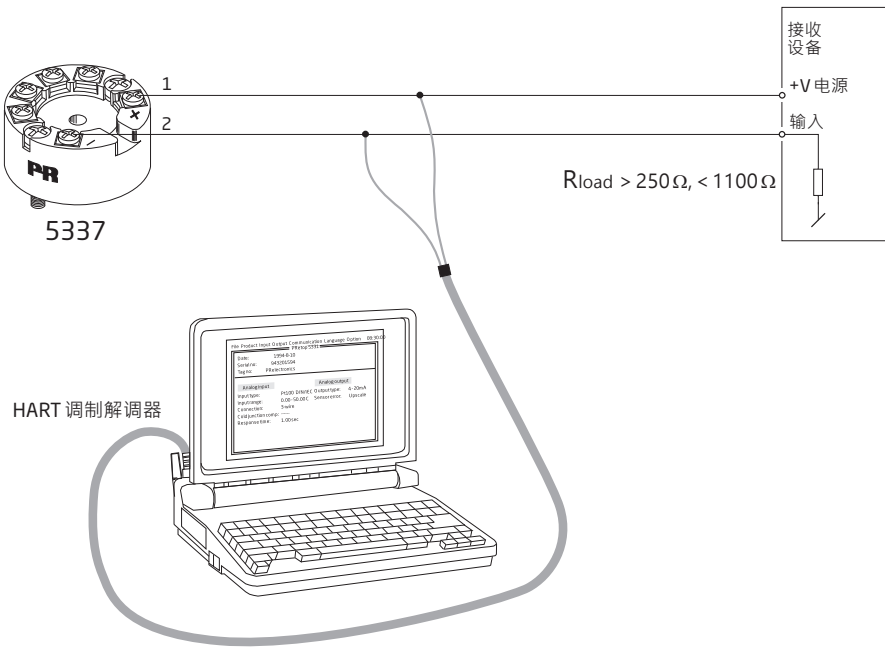

3: HART 通信器

有关配置相关内容，请参考下图。要访问特定产品菜单，HART 通信器必须装有 PR electronics A/S DDL 驱动文件。可以从 HART Communication Foundation 或 PR electronics A/S 订购它们。

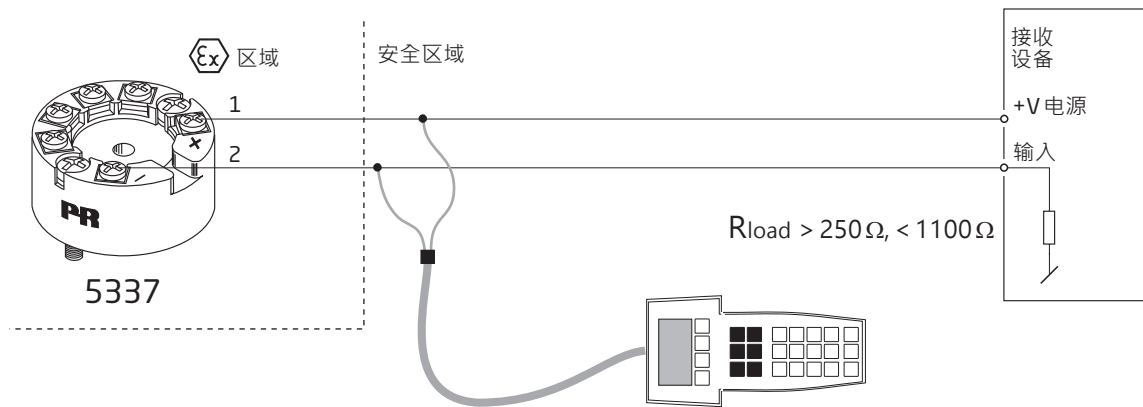

变送器多点模式连接

- HART 通信器或 PC 调制解调器可以连接 AB 或 BC。

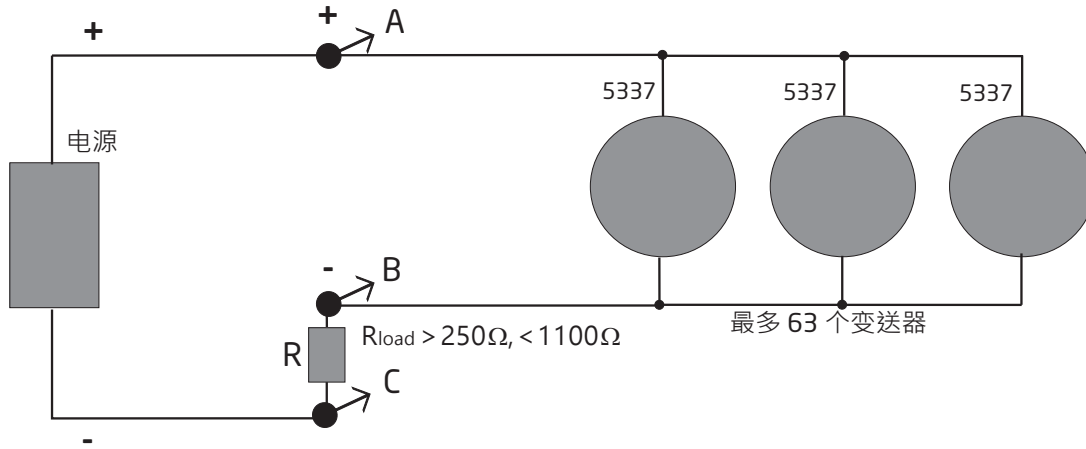

- 二线 HART 数字通讯，可以并联连接最多 63 个变送器。
- 在连接之前，每个变送器必须配置一个唯一的轮询地址，范围从 1 到 63。如果两个变送器配置了相同的地址，则两者都将被排除。变送器必须配置为多点模式（固定输出 4 mA 不变）。因此，回路中的最大电流为 252 mA。
- 通过 HART 通信器或 HART 调制解调器进行通信。
- PReset 配置软件可以将单个变送器配置为多点模式，并为其提供唯一的轮询地址。

机械规格

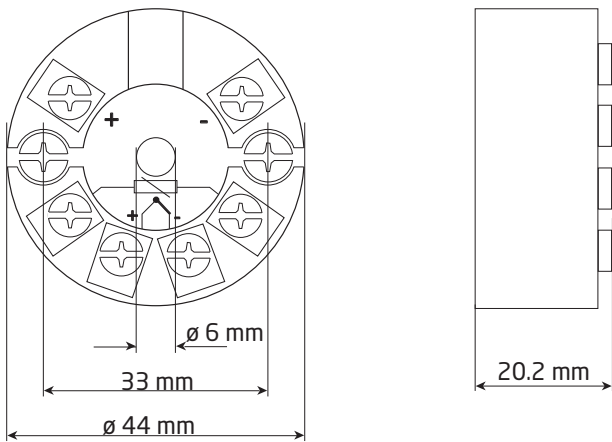

传感器电缆的连接

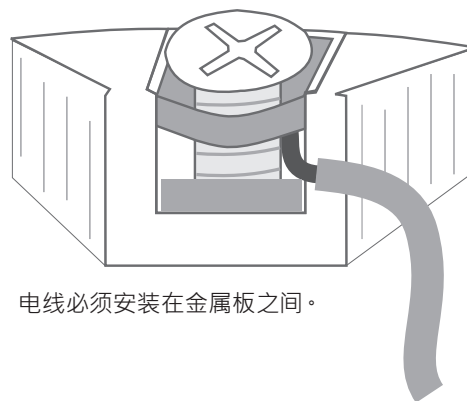

ATEX 安装图 5335QA02-V5R0

为安全安装 5335A 或 5337A，必须遵守以下规定。该模块仅由熟悉适用于该地区国家和国际法律、指令和标准的合格专业人员安装。设备制造年份由序列号的前两位数字指示。

ATEX 认证 DEKRA 20ATEX0109 X

标记牌



II 3 G Ex nA [ic] IIC T6 ... T4 Gc

II 3 G Ex ec [ic] IIC T6 ... T4 Gc

II 3 G Ex ic IIC T6 ... T4 Gc

II 3 D Ex ic IIIC Dc

标准

EN 60079-0: 2018, EN 60079-11: 2012,

EN 60079-15: 2010, EN 60079-7:2015 +A1: 2018

端子 3,4,5,6	端子 1,2	端子 1,2	端子 1,2
Ex ic IIC, Ex ic IIIC	Ex ic IIC, Ex ic IIIC	Ex ic IIC, Ex ic IIIC	Ex nA, Ex ec
Uo: 9.6 V Io: 28 mA Po: 67 mW Lo: 35 mH Co: 3.5 μ F	Ui = 35 V Ii = 110 mA Ci = 1 nF Li = 0 μ H	Ui = 24 V Ii = 260 mA Ci = 1 nF Li = 0 μ H	Umax ≤ 35 VDC 或 Umax ≤ 24 VDC

Ex ic IIC, Ex ic IIIC 温度等级	环境温度范围	
	Ui=35 V	Ui=24 V
T6	-40°C 至 +54°C	-40°C 至 +63°C
T5	-40°C 至 +69°C	-40°C 至 +78°C
T4	-40°C 至 +85°C	-40°C 至 +85°C

Ex ec, Ex nA 温度等级	环境温度范围	
	Vmax=35 V	Vmax=24 V
T6	-40°C 至 +43°C	-40°C 至 +55°C
T5	-40°C 至 +85°C	-40°C 至 +85°C
T4	-40°C 至 +85°C	-40°C 至 +85°C

安装说明

如果外壳由非金属塑料材料制成，应避免变频器外壳上的静电荷。

如果变频器安装在需要使用设备保护级别 Gc 的爆炸性环境中并应用 Ex ic 保护类型，则变频器应安装在可根据 EN 60529 提供至少 IP20 防护等级的外壳中，并且适合应用并正确安装。

如果变频器安装在需要使用设备保护等级 Dc 的爆炸性环境中，则变频器应安装在单独认证的外壳中，该外壳可根据 EN 60079-0 提供至少 IP5X 的防护等级，并且适合应用并正确安装。外壳的表面温度比环境温度高 +20 K，确定没有灰尘层。

环境温度范围: -40°C 至 +85°C.

如果变频器安装在需要使用设备保护级别 Gc 的爆炸性环境中并应用 Ex nA 或 Ex ec 保护类型，则变频器应安装在单独认证的外壳中，该外壳可根据 EN 60079-0 提供至少 IP54 的防护等级，并且适合应用并正确安装。

如果变频器安装在需要使用设备保护级别 Gc 的爆炸性环境中并应用 Ex nA 或 Ex ec 保护类型，则该设备只能在不超过 EN 60664-1 中定义的污染等级 2 的区域中使用。

ATEX 安装图 5335QA01-V5R0



为安全安装 5335D 或 5337D，必须遵守以下规定。该模块仅由熟悉适用于该地区国家和国际法律、指令和标准的合格专业人员安装。设备制造年份由序列号的前两位数字指示。

ATEX 认证

DEKRA 20ATEX0108 X

标记牌



II 1 G Ex ia IIC T6...T4 Ga

II 2 D Ex ia IIIC Db

I M1 Ex ia I Ma

标准

EN 60079-0: 2018, EN 60079-11: 2012

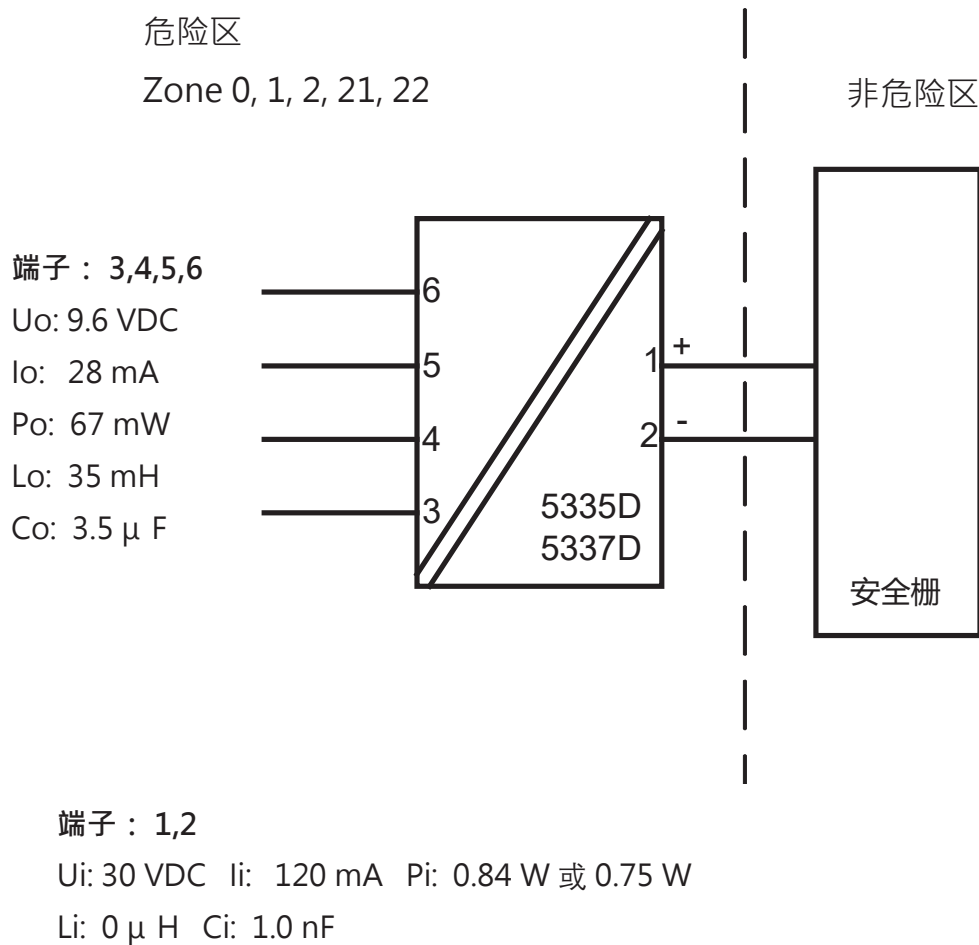

温度等级	环境温度范围	
	Pi: 0.84 W	Pi: 0.75 W
T6	-40°C 至 +47°C	-40°C 至 +50°C
T5	-40°C 至 +62°C	-40°C 至 +65°C
T4	-40°C 至 +85°C	-40°C 至 +85°C

安装说明

如果外壳由非金属塑料材料制成，应避免变送器外壳上的静电荷。

如果变送器安装在需要使用设备保护级别 Ga 的爆炸性环境中，则变送器应安装在可根据 EN 60529 提供至少 IP20 防护等级的外壳中，并且适合应用并正确安装。

如果变送器安装在需要使用设备防护等级 Ga 或 Ma 的爆炸性环境中，并且如果外壳是铝制的，则必须将其安装在能避免因冲击和摩擦火花而形成点火源的位置。

如果变送器安装在需要使用设备保护等级 Db 的爆炸性环境中，则变送器应安装在单独认证的外壳中，该外壳可根据 EN 60079-0 提供至少 IP5X 的防护等级，并且适合应用并正确安装。外壳的表面温度比环境温度高 +20 K，确定没有灰尘层。

环境温度范围: -40°C 至 +85°C.

如果变送器安装在需要使用设备保护等级 Ma 的爆炸性环境中，则变送器应安装在可根据 EN 60529 提供至少 IP54 防护等级的外壳中，并且适合应用并正确安装。

环境温度范围: -40°C 至 +85°C.

应使用适用于相关应用和正确安装的电缆封口和堵封件。

若环境温度 $\geq 60^\circ\text{C}$ ，则应使用耐热电缆，其额定耐热温度至少应比环境温度高出 20 K。

传感器电路与输入电路并非绝对电气隔离。然而，电路间的电气隔离能够承受 1 分钟交流 500V 的测试电压。

IECEx-installation drawing 5335QI02-V5R0

For safe installation of 5335A and 5337A the following must be observed. The module shall only be installed by qualified personnel who are familiar with the national and international laws, directives and standards that apply to this area. Year of manufacture can be taken from the first two digits in the serial number.

Certificate	IECEx DEK 20.0063X
Marking	Ex nA [ic] IIC T6 ... T4 Gc Ex ec [ic] IIC T6 ... T4 Gc Ex ic IIC T6 ... T4 Gc Ex ic IIIC Dc
Standards	IEC 60079-0: 2017, IEC 60079-11: 2011, IEC 60079-15: 2010, IEC 60079-7:2017

Terminal 3,4,5,6	Terminal 1,2	Terminal 1,2	Terminal 1,2
Ex ic IIC, Ex ic IIIC	Ex ic IIC, Ex ic IIIC	Ex ic IIC, Ex ic IIIC	Ex nA, Ex ec
Uo: 9.6 V Io: 28 mA Po: 67 mW Lo: 35 mH Co: 3.5 μF	Ui = 35 V Ii = 110 mA Ci = 1 nF Li = 0 μH	Ui = 24 V Ii = 260 mA Ci = 1 nF Li = 0 μH	Umax ≤ 35 VDC or Umax ≤ 24 VDC

Ex ic IIC, Ex ic IIIC Temperature Class	Ambient temperature range	
	Ui=35 V	Ui=24 V
T6	-40°C to +54°C	-40°C to +63°C
T5	-40°C to +69°C	-40°C to +78°C
T4	-40°C to +85°C	-40°C to +85°C

Ex ec, Ex nA Temperature Class	Ambient temperature range	
	Vmax=35 V	Vmax=24 V
T6	-40°C to +43°C	-40°C to +55°C
T5	-40°C to +85°C	-40°C to +85°C
T4	-40°C to +85°C	-40°C to +85°C

Installation notes

If the enclosure is made of non-metallic plastic materials, electrostatic charges on the transmitter enclosure shall be avoided.

If the transmitter is installed in an explosive atmosphere requiring the use of equipment protection level Gc and applied in type of protection Ex ic, the transmitter shall be mounted in an enclosure that provides a degree of protection of at least IP20 according to IEC 60259, and that is suitable for the application and correctly installed.

If the transmitter is installed in an explosive atmosphere requiring the use of equipment protection level Dc, the transmitter shall be mounted in a separately certified enclosure that provides a degree of protection of at least IP5X according to IEC 60079-0, and that is suitable for the application and correctly installed. The surface temperature of the outer enclosure is +20 K above the ambient temperature, determined without a dust layer.
Ambient temperature range: -40°C to +85°C.

If the transmitter is installed in an explosive atmosphere requiring the use of equipment protection level Gc and applied in type of protection Ex nA or Ex ec, the transmitter shall be mounted in a separately certified enclosure that provides a degree of protection of at least IP54 according to IEC 60079-0, and that is suitable for the application and correctly installed.

If the transmitter is installed in an explosive atmosphere requiring the use of equipment protection level Gc and applied in type of protection Ex nA or Ex ec, the equipment shall only be used in an area of not more than pollution degree 2, as defined in IEC 60664-1.

IECEX-installation drawing 5335QI01-V5R0



For safe installation of 5335D or 5337D the following must be observed. The module shall only be installed by qualified personnel who are familiar with the national and international laws, directives and standards that apply to this area. Year of manufacture can be taken from the first two digits in the serial number.

Certificate	IECEX DEK 20.0063X
Marking	Ex ia IIC T6...T4 Ga Ex ia IIIC Db Ex ia I Ma
Standards	IEC 60079-0: 2017, IEC 60079-11: 2011

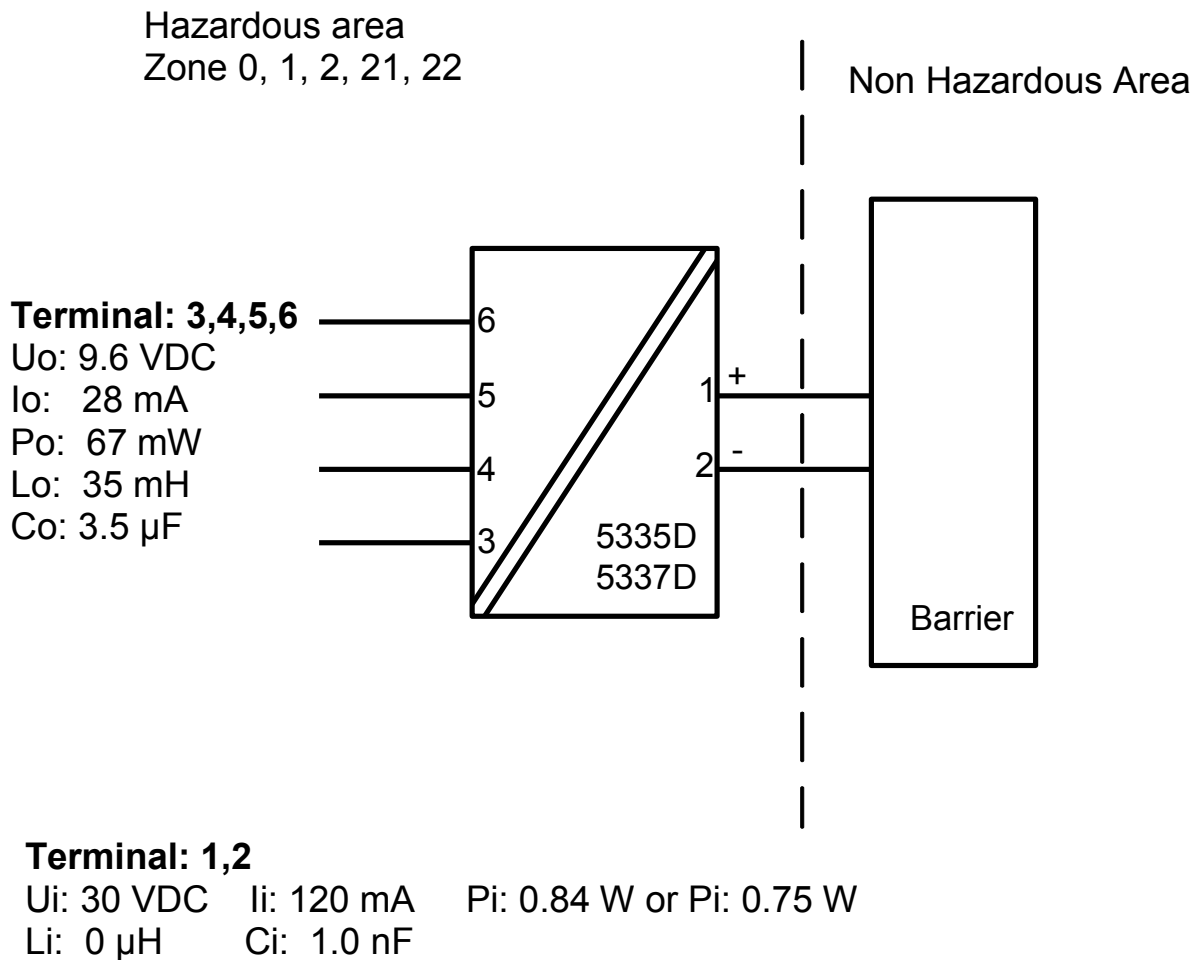

Temperature Class	Ambient temperature range	
	Pi: 0.84 W	Pi: 0.75 W
T6	-40°C to +47°C	-40°C to +50°C
T5	-40°C to +62°C	-40°C to +65°C
T4	-40°C to +85°C	-40°C to +85°C

Installation notes

If the enclosure is made of non-metallic plastic materials, electrostatic charges on the transmitter enclosure shall be avoided.

If the transmitter is installed in an explosive atmosphere requiring the use of equipment protection level Ga, the transmitter shall be mounted in an enclosure that provides a degree of protection of at least IP20 according to IEC 60529, and that is suitable for the application and correctly installed.

If the transmitter is installed in an explosive atmosphere requiring the use of equipment protection level Ga or Ma, and if the enclosure is made of aluminum, it must be installed such, that ignition sources due to impact and friction sparks are excluded.

If the transmitter is installed in an explosive atmosphere requiring the use of equipment protection level Db, the transmitter shall be mounted in a separately certified enclosure that provides a degree of protection of at least IP5X according to IEC 60079-0, and that is suitable for the application and correctly installed. The surface temperature of the outer enclosure is +20 K above the ambient temperature, determined without a dust layer.
Ambient temperature range: -40°C to +85°C.

If the transmitter is installed in an explosive atmosphere requiring the use of equipment protection level Ma, the transmitter shall be mounted in an enclosure that provides a degree of protection of at least IP54 according to IEC 60529, and that is suitable for the application and correctly installed.
Ambient temperature range: -40°C to +85°C.

Cable entries and blanking elements shall be used that are suitable for the application and correctly installed.

For an ambient temperature $\geq 60^\circ\text{C}$, heat resistant cables shall be used with a rating of at least 20 K above the ambient temperature.

The sensor circuit is not infallibly galvanically isolated from the input circuit. However, the galvanic isolation between the circuits is capable of withstanding a test voltage of 500 VAC for 1 minute.

For safe installation of the 5335A and 5337A the following must be observed. The module shall only be installed by qualified personnel who are familiar with the national and international laws, directives and standards that apply to this area.

Marking

Class I, Division 2, Group A,B,C,D T6...T4
 Ex nA[ic] IIC T6...T4
 Class I Zone 2 AEx nA[ic] IIC T6...T4

Hazardous Area
 CL I, Div 2, GP ABCD
 CL I, Zone 2, IIC

T4: -40°C to 85 °C
 T6: -40°C to 60 °C

Terminal:

3,4,5,6
 U_o: 9.6 VDC
 I_o: 28 mA
 P_o: 67 mW
 L_o: 45 mH
 C_o: 28 µF

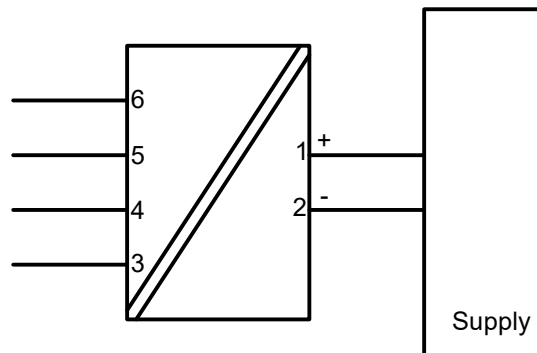

Terminal:

1-2
 Functional Ratings:
 U nominal ≤ 35 VDC;
 I nominal ≤ 3.5 - 23 mA

NI Installation instructions

The transmitter must be installed in an enclosure providing a degree of protection of at least IP54 according to IEC60529 that is suitable for the application and is correctly installed. Cable entry devices and blanking elements shall fulfill the same requirements.

If the enclosure is made of non-metallic materials or of painted metal, electrostatic charging shall be avoided.

Use supply wires with a rating of at least 5 K above the ambient temperature.

Supply from a Class 2 Power Supply with Transient protection or equivalent.

WARNING: Substitution of components may impair suitability for Class I, Division 2

AVERTISSEMENT: la substitution de composants peut nuire à l'aptitude à la Classe I, Division 2.

WARNING: Do not disconnect equipment unless power has been switched off or the area is known to be safe.

AVERTISSEMENT: Ne débranchez pas l'équipement sauf si l'alimentation a été coupée ou si la zone est connue pour être sûre.

Non Incendive field wiring installation

The non incendive field Wiring Circuit concept allows interconnection of Nonincendive Field wiring Apparatus with Associated Nonincendive Field Wiring Apparatus or Associated Intrinsically Safe Apparatus or Associated Apparatus not specially examined in combination as a system using any of the wiring methods permitted for unclassified locations,

$V_{oc} < V_{max}$, $C_a \geq C_i + C_{cable}$, $L_a \geq L_i + L_{cable}$.

CSA Installation drawing 533XQC03

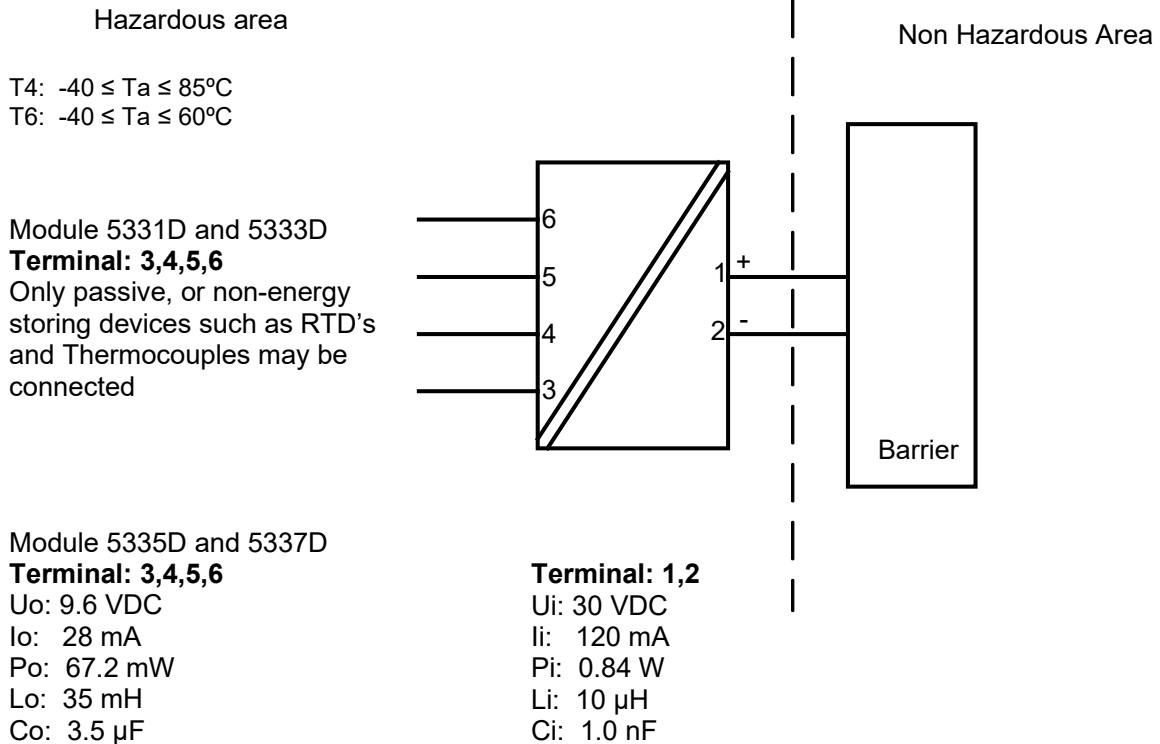

CLASS 2258 04 - PROCESS CONTROL EQUIPMENT - Intrinsically Safe Entity - For Hazardous Locations

CLASS 2258 84 - PROCESS CONTROL EQUIPMENT - Intrinsically Safe Entity - For Hazardous Locations - Certified to US Standards

Class I, Division 1, Groups A, B, C and D T6...T4

Ex ia IIC T6...T4 Ga

Class I, Zone 0, AEx ia IIC Ga

Warning:

Substitution of components may impair intrinsic safety.

The transmitters must be installed in a suitable enclosure to meet installation codes stipulated in the Canadian Electrical Code (CEC) or for US the National Electrical Code (NEC).

FM Installation Drawing

Model 5331D, 5332D, 5333D and 5343B

Hazardous (Classified) Location

Class I, Division 1, Groups, A, B, C, D T4..T6
Class I, Zone 0, AEx ia IIC T4..T6

Ambient temperature limits
T4: -40 to + 85 deg. Celcius
T6: -40 to + 60 deg. Celcius

Terminal 1 , 2
Vmax or Ui: 30 V
Imax or li: 120 mA
Pmax or Pi: 0.84 W
Ci: 1 nF
Li: 10 uH

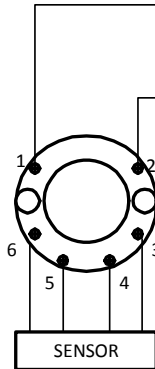

Non Hazardous Location

Associated Apparatus
or Barrier
with
entity Parameters:

$UM \leq 250V$
 $Voc \text{ or } Uo \leq Vmax \text{ or } Ui$
 $Isc \text{ or } Io \leq Imax \text{ or } li$
 $Po \leq Pi$
 $Ca \text{ or } Co \geq Ci + Ccable$
 $La \text{ or } Lo \geq Li + Lcable$

This device must not be connected
to any associated apparatus which
uses or generates more than 250
VRMS

Model 5335D, 5337D

Hazardous (Classified) Location

Class I, Division 1, Groups, A, B, C, D T4..T6
Class I, Zone 0, AEx ia IIC T4..T6

Ambient temperature limits
T4: -40 to + 85 deg. Celcius
T6: -40 to + 60 deg. Celcius

Terminal 1 , 2
Vmax or Ui: 30 V
Imax or li: 120 mA
Pmax or Pi: 0.84 W
Ci: 1 nF
Li: 10 uH

Terminal 3,4,5,6
Vt or Uo: 9.6 V
It or Io: 28 mA
Pt or Po: 67.2 mW
Ca or Co: 3.5 uF
La or Lo: 35 mH

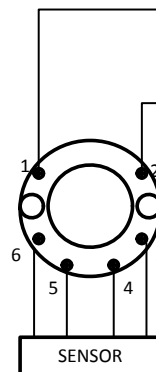

Non Hazardous Location

Associated Apparatus
or Barrier
with
entity Parameters:

$UM \leq 250V$
 $Voc \text{ or } Uo \leq Vmax \text{ or } Ui$
 $Isc \text{ or } Io \leq Imax \text{ or } li$
 $Po \leq Pi$
 $Ca \text{ or } Co \geq Ci + Ccable$
 $La \text{ or } Lo \geq Li + Lcable$

This device must not be connected
to any associated apparatus which
uses or generates more than 250
VRMS

The entity concept

The Transmitter must be installed according to National Electrical Code (ANSI-NFPA 70) and shall be installed with the enclosure, mounting, and spacing segregation requirement of the ultimate application.

Equipment that is FM-approved for intrinsic safety may be connected to barriers based on the ENTITY CONCEPT. This concept permits interconnection of approved transmitters, meters and other devices in combinations which have not been specifically examined by FM, provided that the agency's criteria are met. The combination is then intrinsically safe, if the entity concept is acceptable to the authority having jurisdiction over the installation.

The entity concept criteria are as follows:

The intrinsically safe devices, other than barriers, must not be a source of power.

The maximum voltage $U_i(V_{MAX})$ and current $I_i(I_{MAX})$, and maximum power $P_i(P_{max})$, which the device can receive and remain intrinsically safe, must be equal to or greater than the voltage (U_o or V_{oc} or V_t) and current (I_o or I_{sc} or I_t) and the power P_o which can be delivered by the barrier.

The sum of the maximum unprotected capacitance (C_i) for each intrinsically device and the interconnecting wiring must be less than the capacitance (C_a) which can be safely connected to the barrier.

The sum of the maximum unprotected inductance (L_i) for each intrinsically device and the interconnecting wiring must be less than the inductance (L_a) which can be safely connected to the barrier.

The entity parameters U_o, V_{oc} or V_t and I_o, I_{sc} or I_t , and C_a and L_a for barriers are provided by the barrier manufacturer.

NI Field Circuit Parameters

Model 5331D, 5332D, 5333D, 5335D, 5337D and 5343B

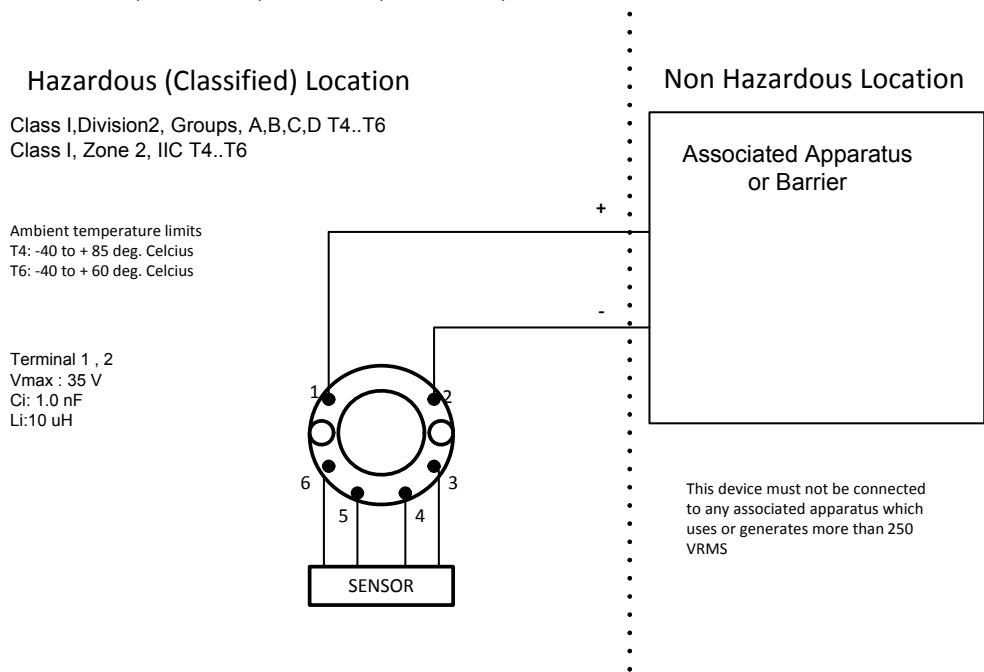

Desenho de Instalação INMETRO



Para instalação segura do 5335A ou 5337A o seguinte deve ser observado. O modelo deve apenas ser instalado por pessoas qualificadas que são familiarizadas com as leis nacionais e internacionais, diretrizes e padrões que se aplicam a esta área.
O ano de fabricação pode ser pego dos dois primeiros dígitos do número de série.

Certificado DEKRA 23.0011 X

Marcas
Ex ec [ic] IIC T6..T4 Gc
Ex ic IIC T6..T4 Gc
Ex ic IIIC Dc

Normas **ABNT NBR IEC 60079-0:2020 Versão Corrigida:2023**
ABNT NBR IEC 60079-11:2013 Versão Corrigida:2017

Terminais 3,4,5,6	Terminais 1,2	Terminais 1,2	Terminais 1,2
Ex ic IIC, Ex ic IIIC	Ex ic IIC, Ex ic IIIC	Ex ic IIC, Ex ic IIIC	Ex ec
Uo: 9,6 V Io: 28 mA Po: 67 mW Lo: 35 mH Co: 3,5 µF	Ui = 35 V Ii = 110 mA Ci = 1 nF Li = 10 µH	Ui = 24 V Ii = 260 mA Ci = 1 nF Li = 10 µH	Umax ≤ 35 Vdc or Umax ≤ 24 Vdc

Ex ic IIC, Ex ic IIIC Classe de temperatura	Faixa de temperatura ambiente	
	Ui=35V	Ui=24V
T6	-40 °C to +54 °C	-40 °C to +63 °C
T5	-40 °C to +69 °C	-40 °C to +78 °C
T4	-40 °C to +85 °C	-40 °C to +85 °C

Ex ec Classe de temperatura	Faixa de temperatura ambiente	
	Umax=35V	Umax=24V
T6	-40 °C to +43 °C	-40 °C to +55 °C
T5	-40 °C to +85 °C	-40 °C to +85 °C
T4	-40 °C to +85 °C	-40 °C to +85 °C

Notas de Instalação.

Se o invólucro for feito de materiais plásticos não metálicos, devem ser evitadas cargas eletrostáticas no invólucro do transmissor.

Se o transmissor for instalado em uma atmosfera explosiva que exija o uso de nível de proteção de equipamento Gc e aplicado no tipo de proteção Ex ic, o transmissor deverá ser montado em um gabinete que forneça um grau de proteção de pelo menos IP20 de acordo com ABNT NBR IEC 60529, e adequado à aplicação e instalado corretamente.

Se o transmissor for instalado em uma atmosfera explosiva que exija o uso de nível de proteção de equipamento Dc, o transmissor deverá ser montado em um invólucro certificado separadamente que forneça um grau de proteção de pelo menos IP5X de acordo com a ABNT NBR IEC 60079-0, e que seja adequado para o aplicativo e instalado corretamente. A temperatura da superfície do invólucro externo é +20 K acima da temperatura ambiente, determinada sem camada de poeira.
Faixa de temperatura ambiente: -40 °C a +85 °C

Se o transmissor for instalado em uma atmosfera explosiva que exija o uso de nível de proteção de equipamento Gc e aplicado no tipo de proteção Ex ec, o transmissor deverá ser montado em um invólucro certificado separadamente que forneça um grau de proteção de pelo menos IP54 de acordo com conforme ABNT NBR IEC 60079-0, e que seja adequado à aplicação e instalado corretamente.

Se o transmissor for instalado em uma atmosfera explosiva que exija o uso de nível de proteção de equipamento Gc e aplicado no tipo de proteção Ex oc, o equipamento deverá ser usado somente em uma área com grau de poluição não superior a 2, conforme definido na IEC 60664-1.

Desenho de Instalação INMETRO



Para instalação segura do 5335D ou 5337D o seguinte deve ser observado. O modelo deve apenas ser instalado por pessoas qualificadas que são familiarizadas com as leis nacionais e internacionais, diretrizes e padrões que se aplicam a esta área.
O ano de fabricação pode ser pego dos dois primeiros dígitos do número de série.

Certificado	DEKRA 23.0011 X
Marcas	Ex ia IIC T6...T4 Ga Ex ia IIIC Db Ex ia I Ma
Normas	ABNT NBR IEC 60079-0:2020 Versão Corrigida:2023 ABNT NBR IEC 60079-11:2013 Versão Corrigida:2017

Áreas classificadas
Zona 0, 1, 2, 21, 22

Áreas não
classificadas

Terminais:
3,4,5,6
Uo: 9,6 VDC
Io: 28 mA
Po: 67 mW
Lo: 35 mH
Co: 3,5 µF

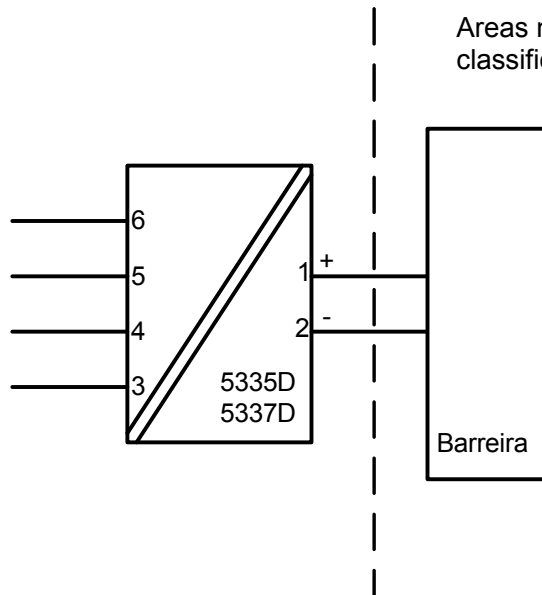

Terminais: 1,2
Ui: 30 VDC li: 120 mA Pi: 0,84 W or Pi: 0,75 W
Li: 10 µH Ci: 1,0nF

Classe de temperatura	Faixa de temperatura ambiente	
	Pi: 0,84W	Pi: 0,75W
T6	-40 °C to +47 °C	-40 °C to +50 °C
T5	-40 °C to +62 °C	-40 °C to +65 °C
T4	-40 °C to +85 °C	-40 °C to +85 °C

Notas de Instalação.

Se o invólucro for feito de materiais plásticos não metálicos, devem ser evitadas cargas eletrostáticas no invólucro do transmissor.

Se o transmissor for instalado em uma atmosfera explosiva que exija o uso de nível de proteção de equipamento Ga, o transmissor deverá ser montado em um invólucro que forneça um grau de proteção de pelo menos IP20 de acordo com a ABNT NBR IEC 60529, e que seja adequado para a aplicação e corretamente instalado.

Se o transmissor for instalado em uma atmosfera explosiva que exija o uso de equipamento de nível de proteção Ga ou Ma, e se o invólucro for feito de alumínio, ele deverá ser instalado de forma que fontes de ignição devido a faíscas de impacto e fricção sejam excluídas.

Se o transmissor for instalado em uma atmosfera explosiva que exija o uso de nível de proteção de equipamento Db, o transmissor deverá ser montado em um invólucro certificado separadamente que forneça um grau de proteção de pelo menos IP5X de acordo com a ABNT NBR IEC 60079-0, e que seja adequado para o aplicativo e instalado corretamente. A temperatura da superfície do invólucro externo é +20 K acima da temperatura ambiente, determinada sem camada de poeira. Faixa de temperatura ambiente: -40 °C a +85 °C

Se o transmissor for instalado em uma atmosfera explosiva que exija o uso de nível de proteção de equipamento Ma, o transmissor deverá ser montado em um invólucro que forneça um grau de proteção de pelo menos IP54 de acordo com a ABNT NBR IEC 60529, e que seja adequado para a aplicação e corretamente instalado. Faixa de temperatura ambiente: -40 °C a +85 °C

Devem ser utilizadas entradas de cabos e elementos de obturação adequados à aplicação e instalados corretamente.

Para uma temperatura ambiente $\geq 60^{\circ}\text{C}$, devem ser utilizados cabos resistentes ao calor com uma classificação de pelo menos 20 K acima da temperatura ambiente.

O circuito do sensor não é infalivelmente isolado galvânicamente do circuito de entrada. Porém, o isolamento galvânico entre os circuitos é capaz de suportar uma tensão de teste de 500Vac por 1 minuto.

文档更新记录

以下列表提供了有关本文档修订的说明。

版本号	日期	说明
104	1837	添加了有关内部功率耗散的规格。 INMETRO 认证更改为 DEKRA。 更新 FM 证书编号。 更新 FM 安装图。
105	2006	获得 5337A 的 CSA 认证。添加安装图。
106	2139	ATEX和IECEx认证已更新 - Ex na 更改为 Ex ec。
107	2202	更新 CSA 安装图。
108	2245	添加了 UKCA。
109	2402	INMETRO认证已更新 - Ex nA 更改为 Ex ec。
110	2450	新 EAC Ex 证书。

无论您身在何处， 我们始终在您身边

无论您身在何处，都将获得我们标志性红色模块的全力支持

我们所有的设备都提供权威的专家服务，且享受长达五年的质量保证。您购买的每款产品都将获得个性化的技术支持和指导，按时交货，保修期内免费维修，丰富的技术文档等服务。

我们的总部在丹麦，我们在世界各地设有办事处并在全球创建授权合作伙伴关系。我们能在全球范围内为您提供本地化

服务。这意味着我们总是伴随在您身边，并且非常了解当地市场。

我们致力于打造高客户满意度产品，并将 PERFORMANCE MADE SMARTER 这一理念传向世界。

了解更多有关我们的保修计划，或想与您所在地区的销售代表会面，请访问 prelectronics.com。

让 PERFORMANCE MADE SMARTER 助您一臂之力

PR electronics 是一家行业领先的、专注于使过程控制更加安全、可靠和高效的技术型公司。自 1974 年以来，我们一直致力于高精度-低功耗型核心技术的开发。秉承这种精神，我们不断地为产品设置新的标准，如此这般能够在客户的过程测量点与其过程控制系统之间进行通信、监控和连接。

我们的创新专利技术来源于大量的研发设施以及对客户需求和工艺过程的深刻理解。简约、专注、勇气、卓越是我们的座右铭。这指引着我们不断帮助一些世界上最大的公司实现更卓越的智能化 (PERFORMANCE MADE SMARTER)。